

# Bistable - impulse relays



bistable - impulse relays – type "ON-OFF"

# RPB-.P.-...

cooperation with illuminated momentary bell switches or control buttons

CE EAC

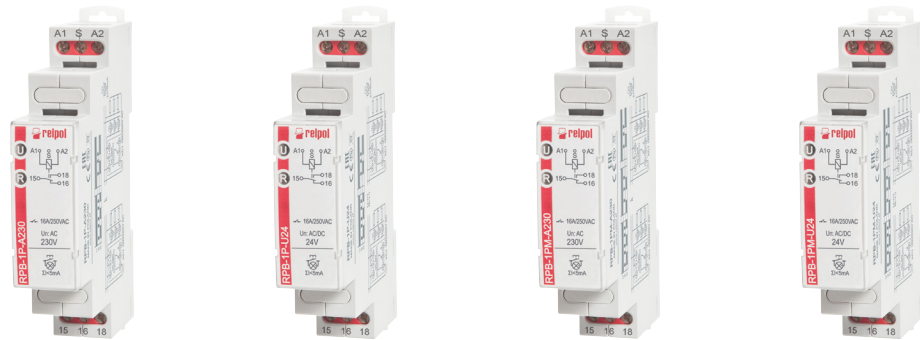

RPB-1P-A230

RPB-1P-U24

RPB-1PM-A230

RPB-1PM-U24

Functions performed		single-function without memory		single-function with memory	
Number & type of contacts		1 CO			
Rated load	AC1	16 A / 250 V AC			
	DC1	16 A / 24 V DC			
Rated supply voltage		230 V AC	24 V AC/DC	230 V AC	24 V AC/DC

bistable - impulse relays – type "ON-OFF"

# RPB-.Z.-...

cooperation with illuminated momentary bell switches or control buttons

CE EAC



RPB-2Z-A230

RPB-2Z-U24

RPB-1ZI-A230

RPB-1ZI-U24

Functions performed		single-function without memory	
Number & type of contacts		2 NO	1 NO
Rated load	AC1	8 A / 250 V AC	16 A / 250 V AC
	DC1	8 A / 24 V DC	16 A / 24 V DC
Rated supply voltage		230 V AC	24 V AC/DC

bistable - impulse relays – type "ON-OFF"

# RPB-...M.-UNI

cooperation with momentary bell switches or control buttons

CE EAC

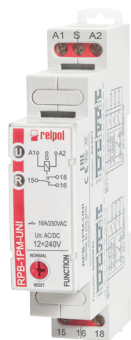

80 A  
(20 ms)  
HALOGEN  
2 500 W  
LED  
500 W

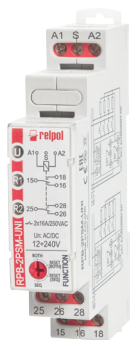

80 A  
(20 ms)  
HALOGEN  
2 500 W  
LED  
500 W

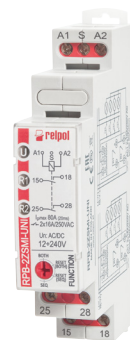

RPB-1PM-UNI

RPB-1ZMI-UNI

RPB-2PSM-UNI

RPB-2ZSMI-UNI

Functions performed	multifunction with memory		multifunction sequential with memory	
Number & type of contacts	1 CO		2 x 1 CO	
Rated load	AC1 DC1		16 A / 250 V AC 16 A / 24 V DC	
Rated supply voltage			12...240 V AC/DC	

bistable - impulse relays – connection diagrams

# RPB-...

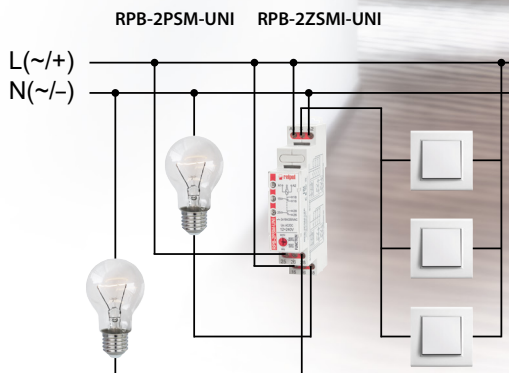
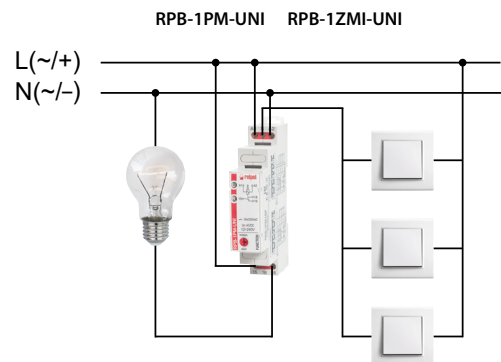
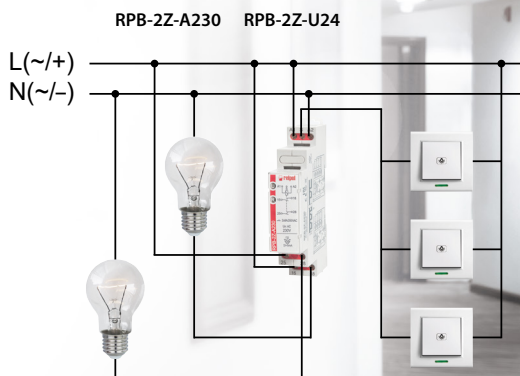
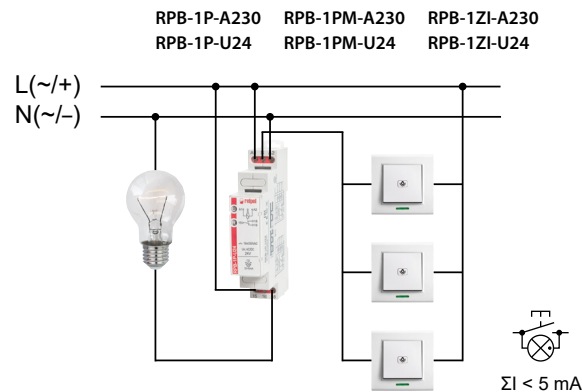

bistable - impulse relays – type "ON-OFF"

# RPB ordering codes

864384	RPB-1P-A230	single-function	bistable - impulse relays type "ON-OFF", single-function without memory, in modular cover, width 17,5 mm, contact 1 CO (changeover), contact material AgSnO <sub>2</sub> , rated supply voltage 230 V AC 50/60 Hz, load 16 A
864383	RPB-1P-U24		bistable - impulse relays type "ON-OFF", single-function without memory, in modular cover, width 17,5 mm, contact 1 CO (changeover), contact material AgSnO <sub>2</sub> , rated supply voltage 24 V AC/DC AC: 50/60 Hz, load 16 A
864390	RPB-1PM-A230		bistable - impulse relays type "ON-OFF", single-function with memory, in modular cover, width 17,5 mm, contact 1 CO (changeover), contact material AgSnO <sub>2</sub> , rated supply voltage 230 V AC 50/60 Hz, load 16 A
864389	RPB-1PM-U24		bistable - impulse relays type "ON-OFF", single-function with memory, in modular cover, width 17,5 mm, contact 1 CO (changeover), contact material AgSnO <sub>2</sub> , rated supply voltage 24 V AC/DC AC: 50/60 Hz, load 16 A
864386	RPB-2Z-A230		bistable - impulse relays type "ON-OFF", single-function without memory, in modular cover, width 17,5 mm, contacts 2 NO (normally open), contact material AgSnO <sub>2</sub> , rated supply voltage 230 V AC 50/60 Hz, load 8 A
864385	RPB-2Z-U24		bistable - impulse relays type "ON-OFF", single-function without memory, in modular cover, width 17,5 mm, contacts 2 NO (normally open), contact material AgSnO <sub>2</sub> , rated supply voltage 24 V AC/DC AC: 50/60 Hz, load 8 A
864388	RPB-1ZI-A230		bistable - impulse relays type "ON-OFF", single-function without memory, in modular cover, width 17,5 mm, contact 1 NO (normally open "inrush"), contact material AgSnO <sub>2</sub> , rated supply voltage 230 V AC 50/60 Hz, load 16 A
864387	RPB-1ZI-U24		bistable - impulse relays type "ON-OFF", single-function without memory, in modular cover, width 17,5 mm, contact 1 NO (normally open "inrush"), contact material AgSnO <sub>2</sub> , rated supply voltage 24 V AC/DC AC: 50/60 Hz, load 16 A
864391	RPB-1PM-UNI	multifunction	bistable - impulse relays type "ON-OFF", multifunction with memory, in modular cover, width 17,5 mm, contact 1 CO (changeover), contact material AgSnO <sub>2</sub> , rated supply voltage 12...240 V AC/DC AC: 50/60 Hz, load 16 A
864393	RPB-1ZMI-UNI		bistable - impulse relays type "ON-OFF", multifunction with memory, in modular cover, width 17,5 mm, contact 1 NO (normally open "inrush"), contact material AgSnO <sub>2</sub> , rated supply voltage 12...240 V AC/DC AC: 50/60 Hz, load 16 A
864392	RPB-2PSM-UNI		bistable - impulse relays type "ON-OFF", multifunction sequential with memory, in modular cover, width 17,5 mm, contacts 2 x 1 CO (changeover), contact material AgSnO <sub>2</sub> , rated supply voltage 12...240 V AC/DC AC: 50/60 Hz, load 2 x 16 A
864394	RPB-2ZSMI-UNI		bistable - impulse relays type "ON-OFF", multifunction sequential with memory, in modular cover, width 17,5 mm, contacts 2 x 1 NO (normally open "inrush"), contact material AgSnO <sub>2</sub> , rated supply voltage 12...240 V AC/DC AC: 50/60 Hz, load 2 x 16 A



Export Sales Department: phone +48 68 47 90 832, 951, export@repol.com.pl, www.repol.com.pl

03/2021